

MIKRO ACM

CLASSIFIER MILL



HOSOKAWA ALPINE

PROCESS TECHNOLOGIES FOR TOMORROWSM



IMPORTANT FEATURES

- Grinding and classifying in one machine
- Compact footprint
- Cool and gentle grinding
- Steep particle size distributions
- Sharp top cut control
- Easily adjustable cut point
- Easy to clean and maintain
- High availability
- Low noise emission
- Low specific energy consumption
- Pressure-shock resistant and wear-protected
- Suitable for combined grinding and drying

ACM schematic

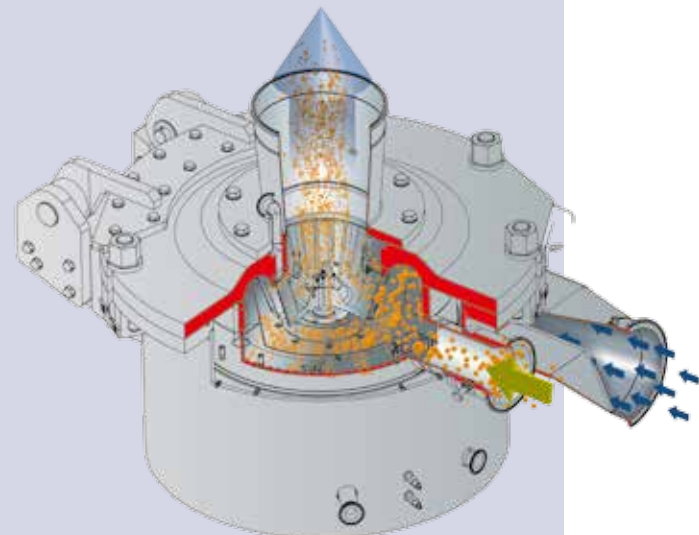

AREA OF APPLICATION

Mikro ACM classifier mills are distinguished by their compact design and intuitive arrangement of all components. Tried-and-tested since 1962, the ACM machine concept has been steadily advanced. The well-engineered overall concept with high air flow, efficient material conveyance and grinding chamber design allows the comminution of material that is sensitive to high temperatures and products that are prone to sedimentation. Combining impact milling with integrated dynamic classification is the ideal solution for fine and ultrafine grinding of soft to medium-hard products and is used in all areas of the industry:

- Chemicals
- Minerals
- Pharma
- Powder coatings
- Food
- Metal



➤ Mikro ACM 40 CL

PRINCIPLE OF OPERATION

The feed material is pneumatically charged to the Mikro ACM. Comminution is the result of particles impacting against the grinding elements of the rotor and against the stationary liner. At beater tip speeds of up to 130 m/s, fineness values of $d_{99} = 10 \mu\text{m}$ are achieved. The product becomes entrained in the cooling, conveying and classifying airflow generated by the downstream fan, drawn through the mill and routed along the guide vanes of the shroud ring .

The integrated dynamic classifier is characteristic of the Mikro ACM. The product/air mixture is distributed uniformly by the guide shroud ring to the rotating

classifier. Because of the two opposing forces and the different masses of the particles, the product is separated in the classifying zone into a coarse fraction and a fine fraction. The coarse material is rejected by the classifying wheel and returned to the grinding zone for further comminution. The fines pass through the classifying wheel and exit the mill. The cut point, i.e. the product's maximum particle size is a function of the classifying wheel speed, which can be infinitely adjusted even during operation.



DESIGN PHILOSOPHY

With its extremely versatile design, the Mikro ACM classifier mill is an unparalleled all-rounder. Advanced over many years, all Mikro ACM mill types are now available with highly optimized features:

- Pneumatic feeding ensures maximum throughput rates and allows versatile setup planning
- Mikro ACM are pressure-shock resistant up to PSR 11 bar. This guarantees maximum explosion protection
- ATEX certification is assured for all our products according to your production requirements
- Low-noise design thanks to constructive noise emission reduction measures
- Tangential air inlet provides optimum airflow conditions, minimises the mill's pressure loss and prevents product sedimentation below the grinding disc
- Optional rinsing of the classifier gap prevents unclassified product from migrating to fines, which is particularly important during ultrafine grinding. The extremely sharp top cut control ensures excellent product quality

APPLICATION TEST CENTRE

Spread over more than 3,000 sqm the Hosokawa, the Alpine application test centre in Augsburg/Germany provides ample space for carrying out tests for system configuration and for determining application-related technical warranty parameters. The following mechanical and thermal process technology operations can be carried out on a production and on a laboratory/pilot scale:

- Size reduction (dry and wet)
- Granulator technology/ shredding
- Air classification
- Wet classification
- Sieving, separation
- Mixing, drying, flash drying
- On-line particle size analysis of dry powders in the range of 0.5 - 850 μm directly at the grinding/classifying system.

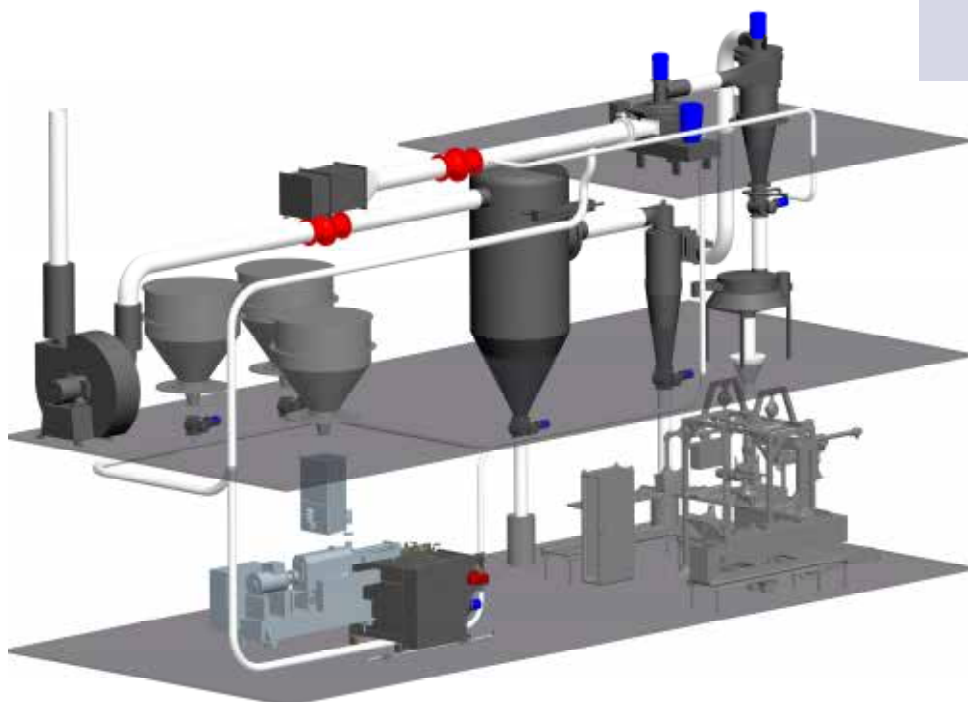

➤ ACM 40 system for the processing of powder coating

IMPORTANT FEATURES MIKRO ACM CX

- Compact design
- Coaxial bearing of classifier and grinding disc
- Tangential air inlet



MIKRO ACM CL

- Separate bearing for classifying wheel and grinding disc with direct classifier
- Horizontal product outlet
- Compact combination with MikroClassifier or cyclone collector possible
- Tangential air inlet



MIKRO ACM CX - DESIGN & FUNCTIONS

The coaxial bearing assembly of the Mikro ACM CX allows both classifier and rotor shafts to be driven from below the mill, so that a vertical product discharge becomes possible. Depending on the application and installation conditions, this straight product discharge can be beneficial, because it eliminates bends at the mill outlet and minimises the risk of product build-up and residue.

The one-part mill housing with motor-driven or manual cover is mounted to the same base frame together with both drive motors. The transmission to the drive shaft is effected via V-belts. All elements are arranged on

the frame and easily accessible, which ensures straightforward cleaning and maintenance. All models from size ACM 200 and up are equipped with oil-circuit lubrication. Mills size ACM 400 and up are equipped with a gear for reliable transmission of the high drive power.

The shaft bearing is equipped with a tried-and-tested sealing system which prevents product ingress as well as the discharge of lubricants. This system ensures a long service life and prevents product contamination. For special applications, bearings with purging air and cooling are available.

- Flow simulation of an ACM 10 CX

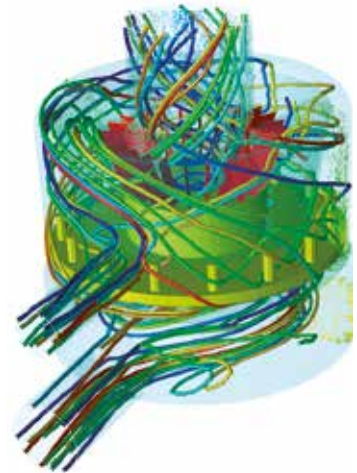

MIKRO ACM CL

The Mikro ACM CL with separate bearings for classifier and grinding disc is recommended for all applications which require a horizontal outlet of the product duct and ancillary system components in close vicinity. This is beneficial for applications that require regular cleaning of parts that come into contact with the product and therefore rely on a compact installation with short product ducts. By separate arrangement of the bearings, heat removal is improved which leads to a long service life, even after continuous operation under heavy-duty conditions. The classifier is driven directly by a motor which is installed in the mill cover, which means that driving components such as the V-belt and pulleys are not required. The grinding disc is equipped with a tried-and-tested bearing with belt drive.



MIKRO ACM EC AND EC-CL

Die Mikro ACM EC (Easy Clean) was developed as a response to the rising demand for minimum cleaning times particularly for applications that require frequent product changes or batch operation. The Mikro ACM EC is tailored to these areas of application. This model has a double-chamber design. After opening the hinged mill cover, the inner grinding chamber can simply be lifted out for cleaning and inspection, as it is neither welded nor screwed to the housing. Depending on the model size, the inner grinding chamber is comprised of several segments, neither of which ever exceeds 25 kg in weight. This makes cleaning and maintenance of the Mikro ACM EC particularly user-friendly, while complying with all health and safety regulations.



LABORATORY AND SMALL BATCH PRODUCTION

The Mikro ACM size 2 or 5 with its new Easy Clean concept is very user-friendly. The main development objective was to reduce the cleaning times during product changes to a minimum. This philosophy has also been applied to all other components of the compact mill system. The mills are used for the following applications:

- Production of small batches for sampling and trials
- Determination of setting and optimization parameters for other
- ACM sizes

The Mikro ACM 5 EC is available as a compact unit or in a customized arrangement. With a footprint of only 8.25 m², the roller-borne system can be installed as required, as only connection to the mains and to pressurized air is needed.

It is comprised of a mill, a cyclone collector or MikroClassifier, residual dust collector, air conditioning, side channel blower, metering and discharge devices. The components are available in explosion pressure-shock resistant (PSR 11) or non-PSR design.

IMPORTANT FEATURES MIKRO ACM EC / EC-CL

- Tailored for powder coating, pharma and food production
- Particularly suitable for frequent product changes
- 50 % less time for cleaning
 - High availability
 - Significant savings
- Low-noise operation
- Tangential air inlet
- Air-cooled liner for temperature-sensitive products
- Also available in CL design. The combination of the Mikro ACM EC with the design features of the CL type mill combines the benefits of both types in one machine





APPLICATION EXAMPLE POWDER COATING (EPOXY)

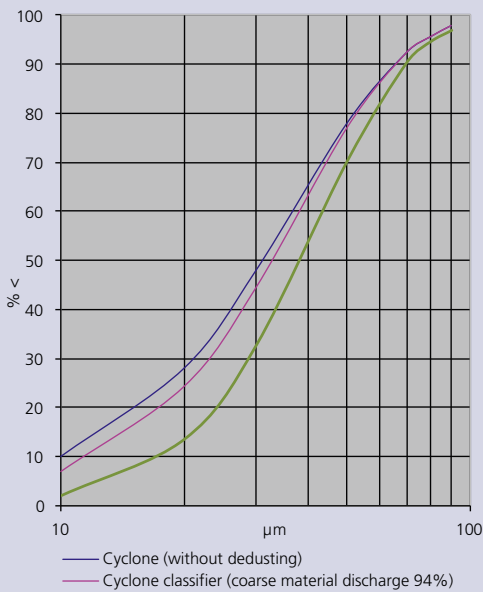

IMPORTANT FEATURES

- Easy cleaning after product changes
- High availability
- Steep particle size distribution
- Low noise emission
- Pressure-shock resistant up to PSR 11
- Several wear protection options

- 1 Mikro ACM classifier mill
- 2 Mikro Classifier CC
- 3 Cyclone

- A Feed material
- B End product

- Line example with Mikro ACM -
For alternating classifier or cyclone operation

APPLICATION EXAMPLE POWDER COATING

During the production of powder coating, chips are ground and classified to suit the specification. Special importance is attached to easy operation, cleaning and maintenance of all machines and components.

With this objective in mind, we continuously advance and optimize our machines so as to accommodate the increasingly exacting quality requirements of powder coating applications.

The concept shown here is comprised of air conditioning, Mikro ACM classifier mill, MikroClassifier CC, cyclone, fine particulate air filter, sieve screen and packaging unit and is suitable for

alternating cyclone or classifier operation. The swivelling cyclone bearing allows fast and easy alternation between operating modes simply by changing the product duct. The sieve screen and packaging unit is mobile and can be positioned below the cyclone or classifier, depending on the operating mode. An optional cyclone/ classifier combination is also available – this alternative requires no changeover.

The grinding and classifier system is pressure-shock resistant to PSR 11. In case of a dust explosion, the integrated explosion protection valves prevent propagating flame fronts and pressure shocks from getting out into the open.

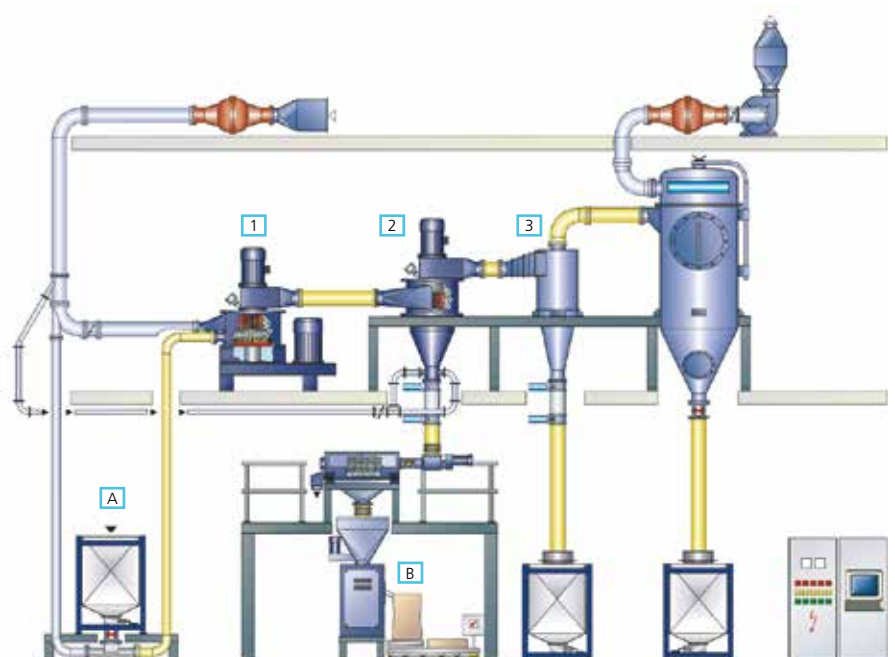



PRACTICAL EXAMPLES FROM THE CHEMICAL INDUSTRY

Product	End-product fineness	Throughput kg/h*	Machine size
Aluminium hydroxide	99 % < 45 µm	150	ACM 15
Aluminium hydroxide	50 % < 4.4 µm 50 % < 7.5 µm	900 4,500	ACM 300
Ammonium phosphate	99 % < 71 µm	110	ACM 10
Anhydrite	90 % < 35 µm	5,000	ACM 150
Calcium stearate	99 % < 71 µm	375	ACM 10
Formaldehyde resin	99.9 % < 74 µm	1,000	ACM 30
Melamine resin	99 % < 100 µm	290	ACM 10
Pesticide (Bisphenol A)	99 % < 63 µm	370	ACM 10
Phenolic resin	99 % < 77 µm	90	ACM 2
Pigments	100 % < 100 µm	100	ACM 10
Carbon black	99 % < 30 µm	160	ACM 15
Silicagel	97 % < 60 µm** 50 % < 30 µm	140	ACM 15 MikroClassifier CC
Vulkanization accelerator	99 % < 63 µm	740	ACM 10
Citric acid	99.5 % < 53 µm 50 % < 20 µm	420	ACM 50
Citric acid	85 % < 180 µm	1,200	ACM 30

* Reference value

** Fineness level after dust removal

PIGMENTS

Pigments are dyeing substances which are added to a variety of materials. These are categorized into inorganic and organic pigments. The first group is comprised of natural inorganic pigments such as ochre and synthetic inorganic pigments such as white pigments or ferrous oxide. Synthetic pigments such as azo pigments account for the largest group of organic pigments.



POWDER COATING

Powder coating consists of solvent-free coating materials in powder form, which produce a coating layer after heat-induced melting and curing.

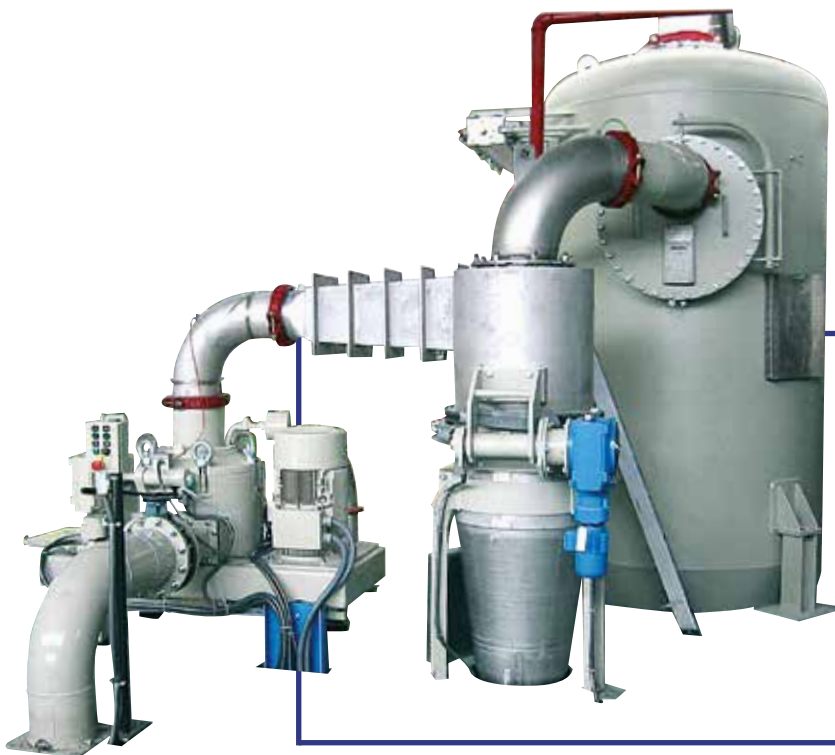

➤ Mikro ACM 40 CX PSR 11 grinding system

Powder coating	End-product fineness	Fine size reduction Cyclone classifier **	Coarse material discharge	Throughput kg/h*	Machine size
Standard grades Epoxy, polyester, Hybrids	d ₁₀ = 10 µm d ₅₀ = 35 µm d ₉₀ = 63 µm	without classifier	-	675	ACM 30
Acrylate resin	d ₅₀ = 30 µm d ₉₀ = 65 µm	8-12 % < 10 µm	90 - 95 %	520	ACM 30

* Nominal capacity (depending on the product, throughputs may vary by +/- 40%)

** Cyclone classifier (replaceable head design, easy change-over to cyclone)



APPLICATION EXAMPLE
SUGAR

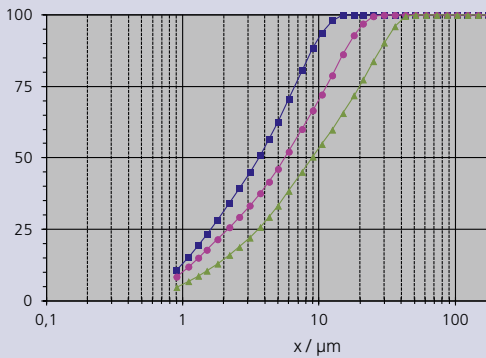

IMPORTANT FEATURES

- > WIP (wash in place)
- > Pressure-shock resistant design
- > Wear protection concept
- > Airflow cooling
- > Comminution protected from product ingress
- > Wide operation range thanks to easy variation of the classifying wheel speed

APPLICATIONS IN THE FOOD INDUSTRY

Mikro ACM line concept has been adapted to accommodate the requirements of the food industry.

This includes challenges which occur during the abrasive comminution of cocoa press cake or ultrafine grinding of lactose and require regular cleaning intervals.

Our customer-oriented line concepts provide a solution for every problem, e.g. pressure-shock resistant wear concepts which helps you reduce your running costs or WIP (wash in place), the tried-and-tested process for better line cleaning,

which involves cleaning at regular intervals, depending on the product fineness level.

Chocolate crumb grinding is becoming increasingly popular. Chocolate crumb is a mixture of whey powder, sugar and cocoa. The particle size distribution that can be achieved is of major importance for subsequent process steps. Mikro ACM is perfect for comminution of the individual mixture components if required.

The Mikro ACM is also ideal for grinding food additives such as citric acid or tartaric acid or animal feedstuff.

1 Mikro ACM classifier mill

A Feed material

B End product

> Line example with Mikro ACM - for grinding cocoa press cake

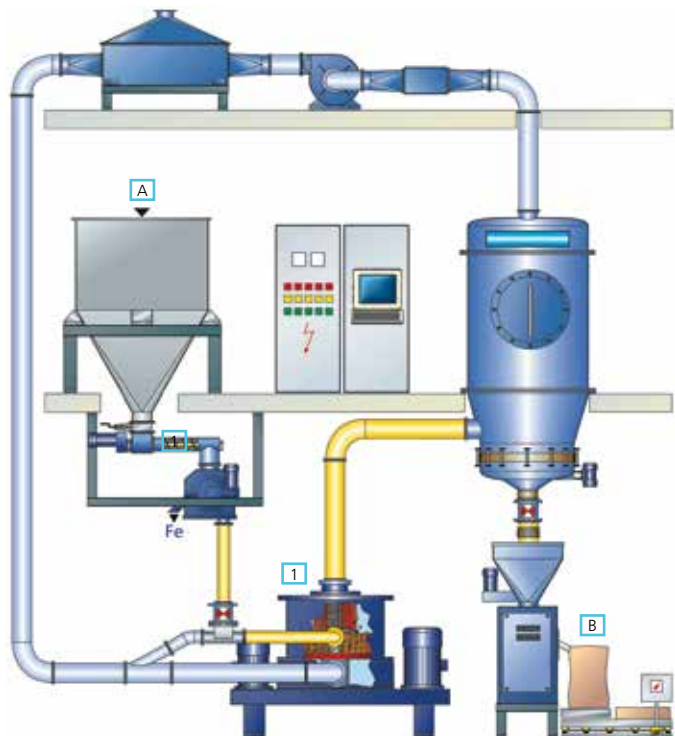



COCOA

Cocoa is used in many areas of the confectionary industry, e.g. in chocolates, chocolate bars, biscuits or drinking chocolate. The quality of the chocolate is determined by roasting, but also by grinding or the cocoa beans to the right particle size.



LAKTOSE

Lactose is milk sugar, which is a by-product of cheese manufacturing. Lactose is used in food, e.g. in sauces, soups and confectionary, but also in baby and infant food.

PRACTICAL EXAMPLES

Product	End-product fineness*	Throughput kg/h ACM 10
Dextrose	99 % < 20 µm	9.3
Fish meal	99 % < 100 µm	100
Raspberries dried	99 % < 100 µm	67
Cocoa	99,7 % < 75 µm	300
Cocoa shells	99.5 % < 75 µm	25
Lactose	99 % < 30 µm 80 % < 75 µm 50 % < 75 µm	137 330 660
Pectin	99 % < 250 µm	170
Pregelatinised starch	99 % < 200 µm	218
Sorbitol	99 % < 300 µm	230
Tobacco	95 % < 125 µm	100
Tartaric acid	99 % < 90 µm	428
Xanthan gum	99 % < 90 µm	27
Sugar	99 % < 63 µm 99 % < 25 µm 99 % < 11 µm	240 105 32

* Powder fineness in % < µm – Measuring points of the particle size distribution. Reference values.



➤ Mikro ACM 150 CX



EXAMPLE OF USE

Gypsum grinding with product ingress protection article size distribution ACM 60

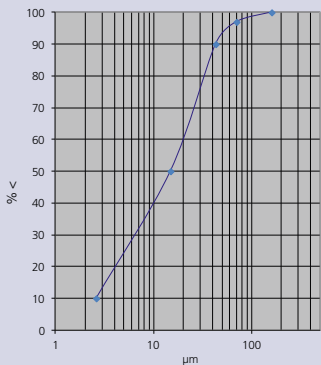

IMPORTANT FEATURES

- Sharp top cut control at 160 µm
- High throughput rate in restricted spaces
- Minimum specific energy consumption
- Combined drying and pulverising option
- Effective wear protection

APPLICATION IN THE MINERAL POWDER INDUSTRY

The Mikro ACM classifier mill with its compact design is generally suitable for installation in restricted spaces. This is a major benefit, particularly in cases that require its integration into existing systems. Many modern applications in the mineral powder industry require fineness levels which can no longer be achieved by impact milling or are too complex for ball classifier mills and bowl mills. At the same time, this process requires an extremely sharp top cut control.

production without product ingress and a top cut control of 100 % < 160.

The Mikro ACM design allows the use of hot process air e.g. for reducing the residual moisture in products such as diatomite. During processing of more abrasive products such as:

- Wollastonite
- Diatomite
- Talcum
- Calcium carbonate

The Mikro ACM provides a variety of options for this area of application. The integrated air classifier allows gypsum

the Mikro ACM can be protected from wear by adding tungsten carbide, aluminium oxide or zirconium oxide ceramic.

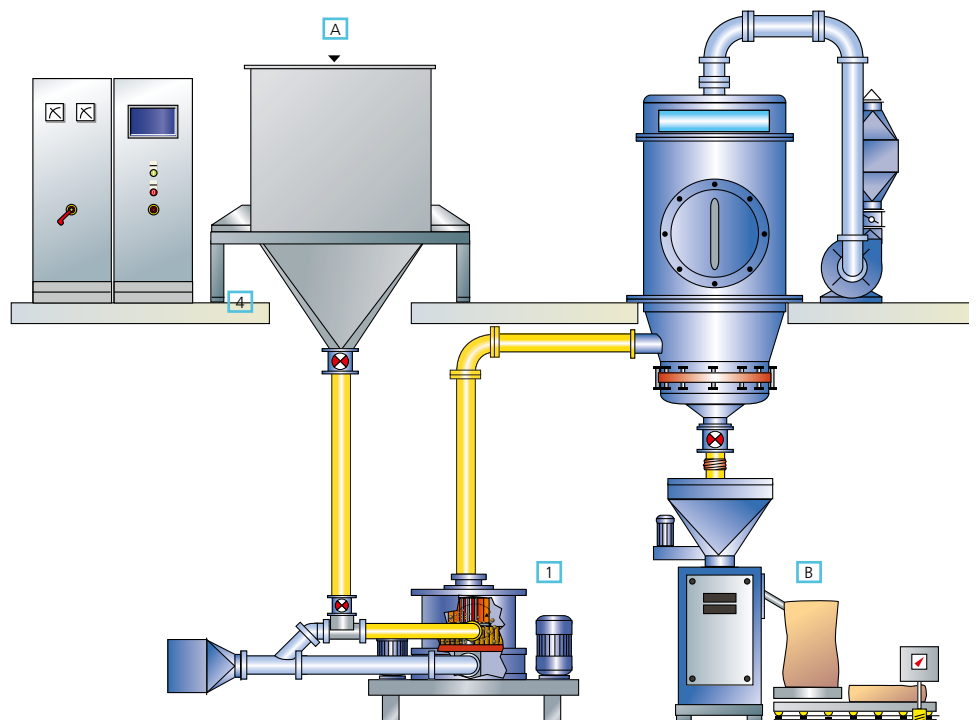

1 Mikro ACM classifier mill

A Feed material

B End product

➤ Line example with Mikro ACM - for gypsum grinding



PRACTICAL EXAMPLES

Product	End-product fineness*	Throughput t/h ACM 200
Aluminium hydroxide	90 % < 32 µm	1.5
Lignite	97 % < 90 µm	2.3 (with drying)
Calcium carbonate	97 % < 25 µm 97 % < 32 µm	2.9 4.1
Diatomite	97 % < 75 µm	3.6 (with drying)
Natur gypsum	99.99 % < 100 µm	4.5
FGD-gypsum	99.9 % < 90 µm	8.5
Wollastonite	97 % < 80 µm	1.6

* Powder fineness in % < µm – Measuring points of the particle size distribution. Reference values.

GYP SUM

Gypsum is one of the oldest mineral binder materials. Natural gypsum is a sediment created by means of precipitation when seawater evaporates. Burning extracts chemically bound water from pure gypsum. Building and modelling plaster is produced at firing temperatures of between 120° C and 130° C.

In addition to nature, environmental technology also produces gypsum. Flue gas desulfurization systems in coal-fired power plants produce FGD gypsum.



➤ ACM 400, driven by 4 synchronous motors installed below the table.

MIKRO ACM SIZES

The Mikro ACM is available in 19 sizes with drive capacities ranging between 3 and 450 kW. Finely tuned grinding chambers and grinding elements as well as airflow and the speed of the classifying wheel and grinding disc allow a direct comparison of the entire range. The grinding levels produced by one mill size can therefore be applied to all other models.

Size	ACM	2	5	10	15	20	25	30	40	50	60	75	100	120	150	200	300	400	500	600
Rotor drive	kW	3	5.5	7.5	11	15	18.5	22	30	37	45	55	75	90	110	160	250	315	375	450
Classifier drive	kW	0.55	1.1	2.2	3	4	4	5.5	7.5	7.5	11	11	15	15	18.5	37	45	75	90	110
Speed (h)	1/min	10660	9400	6,215	6,215	4,970	4,970	4,320	4,320	3,295	2,625	2,625	2,100	2,100	2,100	1,850	1,650	1,400		
Mill (max.)	1/min	11900	10400	8,880	8,880	6,990	6,990	5,770	5,770	4,580	3,750	3,750	2,950	2,950	2,950	2,000	1,850	1,860		
Speed (min.)	1/min	1000	1200	700	700	700	700	600	600	600	600	600	600	800	800	600	600	400		
Classifier (max.)	1/min	5400	500	4,000	4,000	3,250	3,250	2,920	2,920	2,750	2,650	2,650	2,400	2,450	2,400	2,200	2,000	1,860		
Air flow rate	m³/h	330	510	900	1,350	1,800	2,250	2,700	3,600	4,500	5,400	6,750	9,000	10,800	13,500	18,000	27,000	36,000	45,000	54,000
Bypass	m³/h	60	100	180	270	360	450	540	720	900	1,080	1,350	1,800	2,100	2,700	3,000	3,000	4,000	4,000	4,000
Scale-up factor		0.2	0.5	1	1.35	1.8	2.25	2.7	3.6	4.5	5.4	6.75	9	10.8	13.5	18	27	36	45	54
Dimensions																				
Length	mm	630	1,450	1,450	1,450	1,600	1,600	1,750	1,750	1,750	2,450	2,450	2,850	2,850	2,850	3,310	3,740	4,470		
Width	mm	220	580	580	580	700	700	700	700	700	1,060	1,060	1,200	1,200	1,200	1,300	1,500	1,830		
Height	mm	650	790	850	850	1,000	1,000	1,300	1,300	1,300	1,587	1,587	1,731	1,731	1,731	2,180	3,010	2,100		
Weight	kg	500	520	600	620	750	770	900	1,000	1,800	2,400	2,500	2,800	2,800	3,000	9,500	12,500	16,800-19,200		

MIKRO ACM MODELS

Die Mikro ACM is available in four designs for virtually all sizes.

ACM Typ	Features	2	5	10	15	20	25	30	40	50	60	75	100	120	150	200	300	400	500	600
CX	Coaxial rotor bearing	●	●	●	●	●	●	●	●	●	●	●	●	●	●	●	●	●	●	●
CL	Direct classifier drive			●	●	●	●	●	●	●	●	●								
EC	Easy Clean with coaxiale rotor bearing	●	●	●	●	●	●	●	●	●	●	●								
EC-CL	Easy Clean with direct drive			●	●	●	●	●	●	●	●	●								



MACHINE SIZES

Classifier mill ACM	Mill drive (kW)	classifier drive (kW)	Air flow rate (m ³ /h)	Scale-up factor
2	3	0.55	330	0.2
5	5,5	1.1	510	0.5
10	7.5	2.2	900	1
15	11	3	1,350	1.35
20	15	4	1,800	1.8
25	18.5	4	2,250	2,25
30	22	5.5	2,700	2.7
40	30	7.5	3,600	3.6

IMPORTANT FEATURES

- > Compact design
- > Easy to clean
- > Cost-efficient
- > Steep particle size distribution
- > Cool grinding of heat-sensitive materials

MODELS FOR THE PHARMACEUTICAL INDUSTRY

The Mikro ACM classifier mill range for pharmaceutical applications encompasses all mill sizes from the Mikro ACM 2 for smaller batches of up to 10 kg/h right through to the Mikro ACM 40 for industrial production.

Thanks to its coaxial drive, our pharma model of the Mikro ACM has a very compact footprint and can be opened from the top for easy cleaning of all components that come into contact with the product.

The so-called Easy Clean (EC) Design also allows fast and stra-

ightforward line inspection and easy exchange of grinding and classifier elements. The efficient design and footprint of the Mikro ACM makes this model very cost-efficient both in terms of purchase and in maintenance.

In its area of application in the pharmaceutical industry, this model is typically used for the production of auxiliaries and carrier materials, often in mono-production lines with continuous production or for large batches. A high airflow allows cool grinding for processing heat-sensitive materials.

> ACM 40 in pharma design



HOSOKAWA ALPINE Aktiengesellschaft
P. O. Box 10 11 51
86001 Augsburg
GERMANY

Address for visitors and deliveries:

Peter-Doerfler-Straße 13 – 25
DE – 86199 Augsburg

Tel: + 49 821 / 59 06-0

Fax: + 49 821 / 59 06-101

E-mail: mail@alpine.hosokawa.com

www.hosokawa-alpine.com

Subject to change without notice.
All information in this brochure is purely
informative and non-binding.
Our quotations are authoritative
with regard to orders.



HOSOKAWA ALPINE Aktiengesellschaft

Hosokawa Alpine is a member of the Hosokawa Micron Group, a high-performance manufacturer of systems for powder and particle processing, systems for the confectionery industry as well as plastics processing machines and systems. The group is known and reputed the world over for its power of innovation, constant product care and market-oriented R&D. The most important group resources are R&D, engineering and manufacturing as well as customer service in all global markets.

© Hosokawa Alpine 2014. Printed in Germany.